

LANTERNA MONOBLOCCO SINGLE PIECE BELLHOUSINGS



Tabella / Table 1

Taglia / Size	kW	HP	Tipo Type	Lanterna / Bellhousing											Codice per l'ordinazione della lanterna senza lavorazione lato pompa Part number of bellhousing without machining on pump side	
				Dimensioni / Dimensions (mm)												
				D1 min	D2	D3	D4	D5	D6	D7	N fori N. of holes	D8	N fori N. of holes	H1	H2	
80-90	0,55÷1,5	0,75÷2	TH20A	45	130	135	130	165	200	12	4	M10	4	95	16	TH20A-45x
80-90	0,55÷1,5	0,75÷2	THB20	50	130	135	130	165	200	12	4	M10	4	113	16	THB20-50x
80-90	0,55÷1,5	0,75÷2	TH1	63	130	135	130	165	200	12	4	M10	4	126	16	TH1-63x
100-112	2,2÷4	3÷5,5	THB25	50	176	183	180	215	250	14	4	M12	4	112	21	THB25-50x
100-112	2,2÷4	3÷5,5	TH2	63	176	183	180	215	250	14	4	M12	4	136	21	TH2-63x
132	5,5÷9	7,5÷12,5	THB30	80	230	235	230	265	300	14	4	M12	4	130	21	THB30-80x
132	5,5÷9	7,5÷12,5	TH3	80	230	235	230	265	300	14	4	M12	4	170	21	TH3-80x
160-180	11÷22	15÷30	L35C	80	240	253	250	300	350	18	4	M16	4	178	25	L35C-80x
160-180	11÷22	15÷30	TH4	80	240	253	250	300	350	18	4	M16	4	195	25	TH4-80x
200	30	40	TH15	100	235	295	300	350	400	18	4	M16	4	206	25	TH15-100x
225	37÷45	50÷60	TH18	100	260	350	350	400	450	18	8	M16	8	280	25	TH18-100x
250-280	55÷90	75÷125	TH19	100	300	450	450	500	550	18	8	M16	8	290	30	TH19-100x
315S	110	150	TH20	100	300	550	550	600	660	22	8	M20	8	295	35	TH20-100x

LANTERNE COMPONENTI COMPOSITE BELLHOUSINGS

LANTERNA BASE / BASE BELLHOUSING

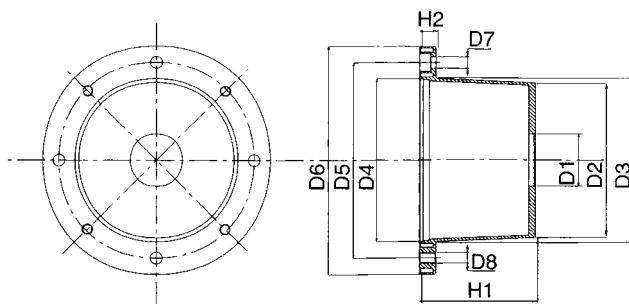
tipo / series **B**

** In funzione della flangia aggiuntiva
** Dimension related to used flange

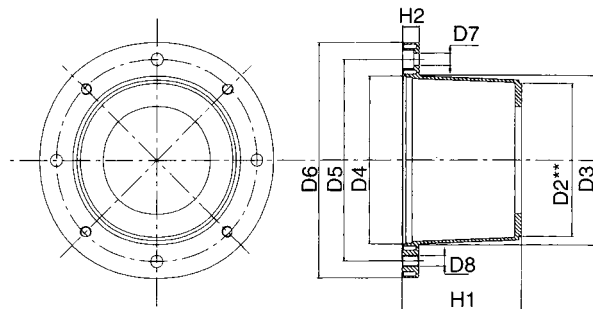

Tabella / Table 2

Taglia / Size	kW	HP	Tipo Type	Lanterna / Bellhousing										
				Dimensioni / Dimensions (mm)										
				D2	D3	D4	D5	D6	D7	N fori N. of holes	D8	N fori N. of holes	H1	H2
80-90	0,55÷1,5	0,75÷2	B2A	126	137	130	165	200	12	4	M10	4	95	16
80-90	0,55÷1,5	0,75÷2	B20	126	137	130	165	200	12	4	M10	4	113	16
80-90	0,55÷1,5	0,75÷2	B1	126	137	130	165	200	12	4	M10	4	126	16
100-112	2,2÷4	3÷5,5	B25	126-171	186	180	215	250	14	4	M12	4	112	21
100-112	2,2÷4	3÷5,5	B2	126-171	186	180	215	250	14	4	M12	4	136	21
132	5,5÷9	7,5÷12,5	B30	126-171-220	235	230	265	300	14	4	M12	4	130	21
132	5,5÷9	7,5÷12,5	B3	126-171-220	235	230	265	300	14	4	M12	4	170	21
160-180	11÷22	15÷30	B35	237	253	250	300	350	18	4	M16	4	155	25
160-180	11÷22	15÷30	B4	237	253	250	300	350	18	4	M16	4	195	25
200	30	40	B40	237	295	300	350	400	18	4	M16	4	155	25
200	30	40	B15	237	295	300	350	400	18	4	M16	4	206	25
225	37÷45	50÷60	B45	237	350	350	400	450	18	8	M16	8	185	25
225	37÷45	50÷60	B18	237	350	350	400	450	18	8	M16	8	280	25
250-280	55÷90	75÷125	B55	237	450	450	500	550	18	8	M16	8	186	30
250-280	55÷90	75÷125	B19	237	450	450	500	550	18	8	M16	8	290	30
315S	110	150	B6A	237	550	550	600	660	22	8	M20	8	230	35
315S	110	150	B66	237	550	550	600	660	22	8	M20	8	295	35
355	160÷200	220÷270	B8	237	685	680	740	800	23	8	M20	8	315	60