

Return Filters

E 212 · E 222

Tank top mounting · Connection up to G1¼ · Nominal flow rate up to 220 l/min



Return Filter E 222

Description**Application**

In the return line circuits of hydraulic systems.

Performance features*Protection against wear:*

By means of filter elements that, in full-flow filtration, meet even the highest demands regarding cleanliness classes.

Protection against malfunction:

By means of full-flow filtration in the system return, the pumps above all are protected from dirt particles remaining in the system after assembly, repairs, or which are generated by wear or enter the system from outside.

Special features

- › By-pass valve:
The location close to the inlet port prevents dirt particles retained by the filter element from entering into the clean oil side.
- › Removable bowl:
In case of maintenance the filter bowl is removed together with the filter element - therefore dirt particles are not flushed back into the tank.
- › Filling filter/By-pass protection strainer:
The filling filter is integrated in the filter element and prevents coarse particles from entering during filling or re-filling due to maintenance or repair reasons. Filling can be carried out at the filter. Therefore the cover must be removed. In operation, the filling filter functions as a by-pass protection strainer and prevents dirt from entering into the tank when the by-pass valve is open.
- › Port for ventilating filter:
The ventilating filter thread connection M42 x 2 allows assembly of a ventilating filter, which assumes ventilation of the tank. The ventilating filter has to be ordered separately.

Filter elements

Flow direction from outside to centre. The star-shaped pleating of the filter material results in:

- › large filter surfaces
- › low pressure drop
- › high dirt-holding capacities
- › long service life

Filter maintenance

By using a clogging indicator the correct moment for maintenance is stated and guarantees the optimum utilization of the filter life.

Materials

Screw-on cap:	Polyester, GF-reinforced
Filter head:	Aluminium alloy
Filter bowl:	Polyamid, CF-reinforced, electrically conducting
Seals:	NBR (FPM on request)
Filtermaterial:	EXAPOR®MAX 2 - inorganic multi-layer microfibre web Paper - cellulose web, impregnated with resin
Filling filter:	Polyamide, reinforced; Polyester web

Accessories

Electrical and optical clogging indicators are available on request. Dimensions and technical data see catalogue sheet 60.20.

Ventilating filters with connection thread M42 x 2 have to be ordered separately. Dimensions and technical data see catalogue sheet 50.20 and 50.30.

Extension pipes or diffusors on the bowl outlet are available on request.

- › Extension pipe: A correct extension pipe length ensures oil outlet below minimum oil level and prevents foaming.

Characteristics

Nominal flow rate

Return filter:

Up to 220 l/min (see Selection Chart, column 2). The nominal flow rates indicated by ARGO-HYTOS are based on the following features:

- › closed by-pass valve at $v \leq 200 \text{ mm}^2/\text{s}$
- › element service life > 1000 operating hours at an average fluid contamination of 0,07 g per l/min flow volume
- › flow velocity in the connection lines $\leq 4,5 \text{ m/s}$

Filling filter:

up to 20 l/min (see Selection Chart, column 3)

Connection

Threaded ports according to ISO 228 or DIN 13.
Sizes see Selection Chart, column 9 (other port threads on request)

Filter fineness

5 $\mu\text{m(c)}$... 30 $\mu\text{m(c)}$
 β -values according to ISO 16889
(see Selection Chart, column 5 and diagram Dx)

Dirt-holding capacity

Values in g test dust ISO MTD according to ISO 16889
(see Selection Chart, column 6)

Hydraulic fluids

Mineral oil and biodegradable fluids (HEES and HETG, see info-sheet 00.20).

With high filling conditions we recommend an electrical conductivity $\leq 500 \text{ pS/m}$ at 20 °C.

Temperature range

-30 °C ... +100 °C (temporary -40 °C ... +120 °C)

Viscosity at nominal flow rate

- › at operating temperature: $v < 60 \text{ mm}^2/\text{s}$
- › as starting viscosity: $v_{\text{max}} = 1200 \text{ mm}^2/\text{s}$
- › at initial operation:
The recommended starting viscosity can be read from the diagram D (pressure drop as a function of the kinematic viscosity) as follows: Find the 70 % Δp of the cracking pressure of the by-pass valve on the vertical axis. Draw a horizontal line so that it intersects the Δp curve at a point. Read this point on the horizontal axis for the viscosity.

Operating pressure

Max. 10 bar

Mounting position

Preferably vertical, outlet downwards

Δp-curves for complete filters in Selection Chart, column 4

D1 Pressure drop as a function of the **flow volume** at $v = 35 \text{ mm}^2/\text{s}$ (0 = casing empty)

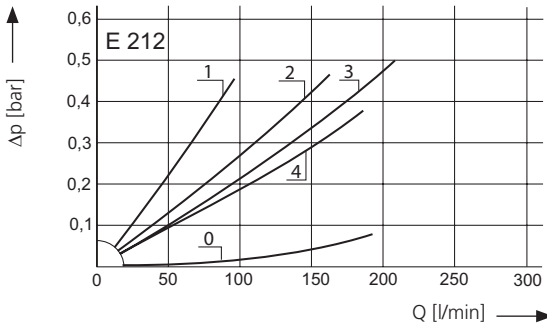

Pressure drop as a function of the **kinematic viscosity** at nominal flow

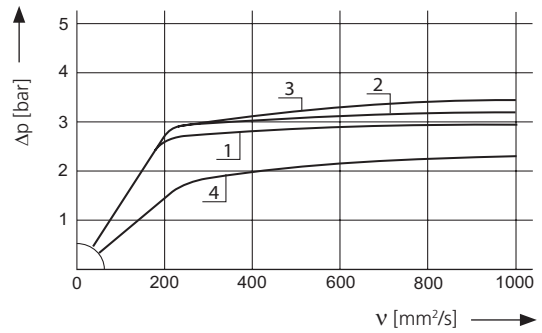

D2 Pressure drop as a function of the **flow volume** at $v = 35 \text{ mm}^2/\text{s}$ (0 = casing empty)

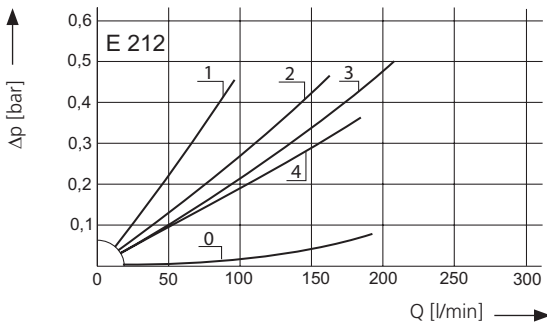

Pressure drop as a function of the **kinematic viscosity** at nominal flow

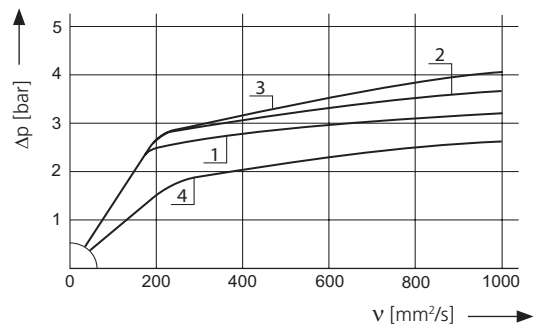

D3 Pressure drop as a function of the **flow volume** at $v = 35 \text{ mm}^2/\text{s}$ (0 = casing empty)

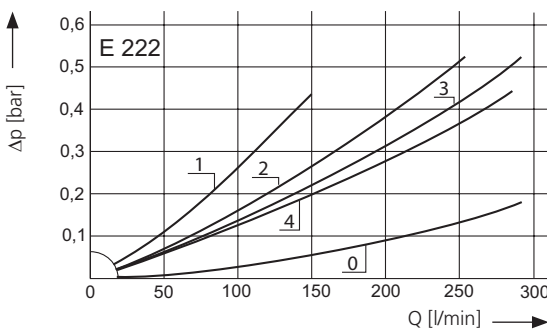

Pressure drop as a function of the **kinematic viscosity** at nominal flow

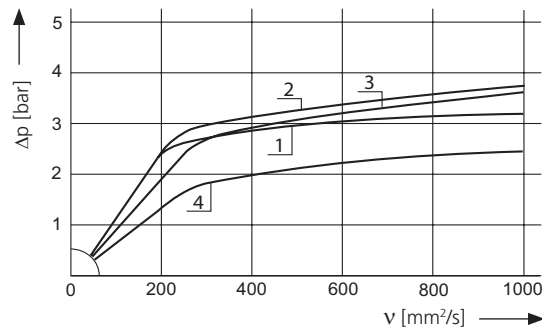

D4 Pressure drop as a function of the **flow volume** at $v = 35 \text{ mm}^2/\text{s}$ (0 = casing empty)

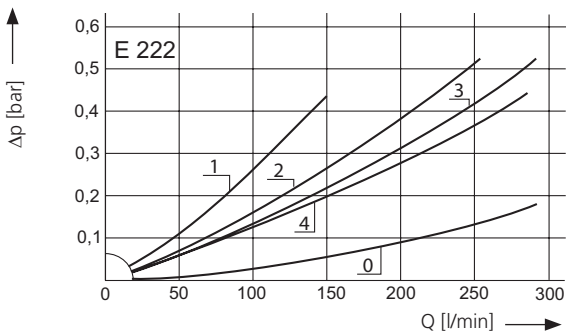

Pressure drop as a function of the **kinematic viscosity** at nominal flow

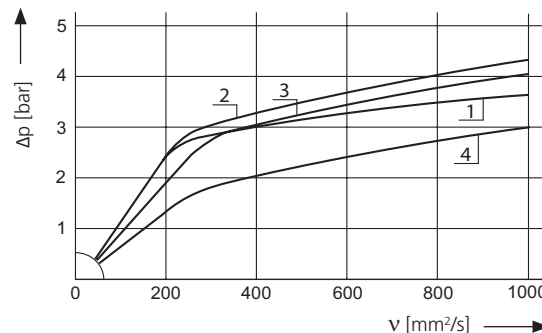

Filter fineness curves in Selection Chart, column 5

Dx Filtration ratio β as a function of particle size x obtained by the Multi-Pass-Test according to ISO 16889

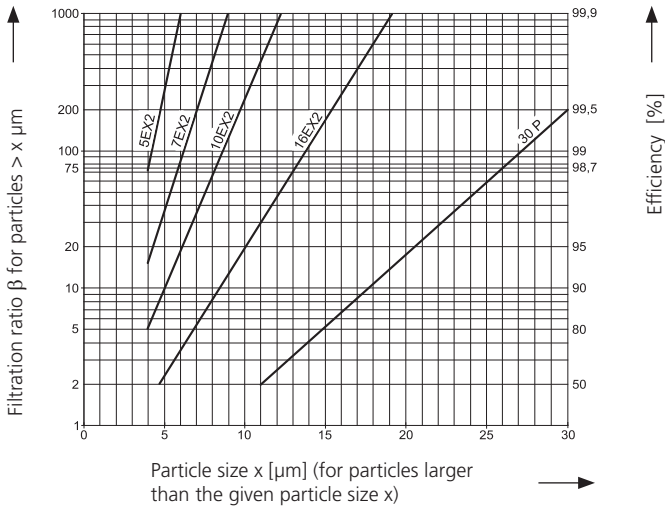

The abbreviations represent the following β -values resp. finenesses:

For EXAPOR®MAX 2- and Paper elements:

- 5EX2 = $\bar{\beta}_{5(c)}$ = 200 EXAPOR®MAX 2
- 7EX2 = $\bar{\beta}_{7(c)}$ = 200 EXAPOR®MAX 2
- 10EX2 = $\bar{\beta}_{10(c)}$ = 200 EXAPOR®MAX 2
- 16EX2 = $\bar{\beta}_{16(c)}$ = 200 EXAPOR®MAX 2
- 30P = $\bar{\beta}_{30(c)}$ = 200 Paper

Based on the structure of the filter media of the 30P paper elements, deviations from the printed curves are quite probable.

For screen elements:

- 40S = screen material with mesh size 40 μ m
- 60S = screen material with mesh size 60 μ m
- 100S = screen material with mesh size 100 μ m

Tolerances for mesh size according to DIN 4189.

For special applications, finenesses differing from these curves are also available by using special composed filter media.

Order Information

All filters are delivered with a plugged clogging indicator connection M12 x 1,5. As clogging indicators either manometers or electrical pressure switches can be used. Optional extension pipes adapt the filter length to various tank depths. For ordering of accessories please use the below mentioned codes.

Order example: The filter E 222-151 has to be supplied with an extension pipe for a mounting depth of 500 mm.

Order description: E 222-151 / EV 500
Part No. (Basic unit) _____

Extension pipe (4 various lengths are available on request) _____

- E 212: EV 300, EV 366, EV 400, EV 466
- E 222: EV 434, EV 500, EV 534, EV 600

For the appropriate ventilating filters with M42x2 thread connection see catalogue sheet 50.20 and 50.30, for the appropriate clogging indicators see catalogue sheet 60.20.

Remarks:

- › The switching pressure of the electrical pressure switch has always to be lower than the cracking pressure of the by-pass valve (see Selection Chart, column 10).
- › Clogging indicators are optional and always delivered detached from the filter.
- › The filters listed in this chart are standard filters. Other designs available on request.

Selection Chart

Part No.	Nominal flow rate Return filter	Nominal flow rate Filling filter ¹	Pressure drop see Diagram D1/curve No.	Filter fineness No.	Dirt-holding capacity see diag. D _x	Filter fineness filling filter / by-pass protection strainer	Filter surface filling filter / by-pass protection strainer	Connection A	Cracking pressure of by-pass	Symbol	Replacement filter element Part No.	Ventilating filter thread connection M42x2	Weight	Remarks
1	l/min	l/min		g	µm	cm ²		bar					kg	15
E 212-159	80	-	D1/1	5EX2	29	-	-	G1¼	2,5	1	V7.0820-03	-	1,7	
E 212-156	140	-	D1/2	10EX2	43	-	-	G1¼	2,5	1	V7.0820-06	-	1,7	
E 212-158	190	-	D1/3	16EX2	43	-	-	G1¼	2,5	1	V7.0820-08	-	1,7	
E 212-151	160	-	D1/4	30 P	21	-	-	G1¼	1,5	1	P7.0820-11 ²	-	1,7	
E 212-359	80	20	D2/1	5EX2	29	450	85	G1¼	2,5	3	K7.0820-03	•	2,0	³
E 212-356	140	20	D2/2	10EX2	43	450	85	G1¼	2,5	3	K7.0820-06	•	2,0	³
E 212-358	190	20	D2/3	16EX2	43	450	85	G1¼	2,5	3	K7.0820-08	•	2,0	³
E 212-351	160	20	D2/4	30 P	21	450	85	G1¼	1,5	3	K7.0820-11 ²	•	2,0	³
E 222-159	130	-	D3/1	5EX2	50	-	-	G1¼	2,5	1	V7.0833-03	-	2,1	
E 222-156	220	-	D3/2	10EX2	74	-	-	G1¼	2,5	1	V7.0833-06	-	2,1	
E 222-158	220	-	D3/3	16EX2	76	-	-	G1¼	2,5	1	V7.0833-08	-	2,1	
E 222-151	220	-	D3/4	30 P	35	-	-	G1¼	1,5	1	P7.0833-11 ²	-	2,1	
E 222-359	130	20	D4/1	5EX2	50	450	85	G1¼	2,5	3	K7.0833-03	•	2,4	³
E 222-356	220	20	D4/2	10EX2	74	450	85	G1¼	2,5	3	K7.0833-06	•	2,4	³
E 222-358	220	20	D4/3	16EX2	76	450	85	G1¼	2,5	3	K7.0833-08	•	2,4	³
E 222-351	220	20	D4/4	30 P	35	450	85	G1¼	1,5	3	K7.0833-11 ²	•	2,4	³

¹ At 200 mm³/s (ISO VG46 at ca. 15°C) ² Paper media supported with metal gauze

³ Open connection for ventilating filter. Please assemble ventilating filter before operating.

Dimensions

Version without connection for ventilating filter

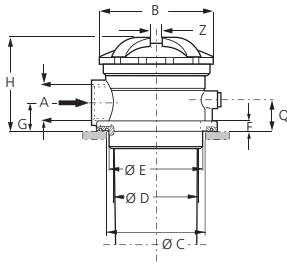

Version with connection for ventilating filter

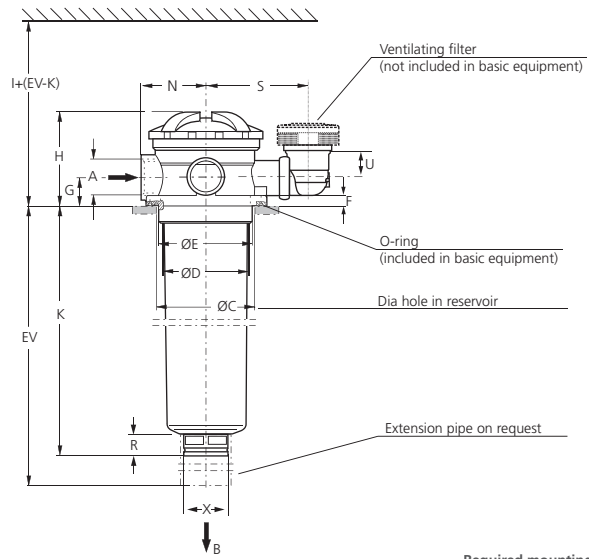

Version with 1 connection

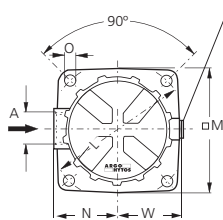

Connection M12 x 1,5 for clogging indicator

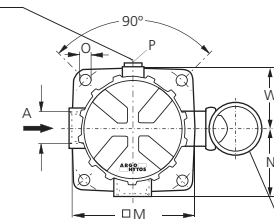

Connection M42 x 2 for ventilating filter

Required mounting surface

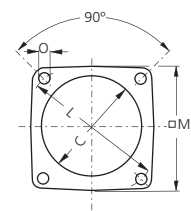

Version with 2 connections on request

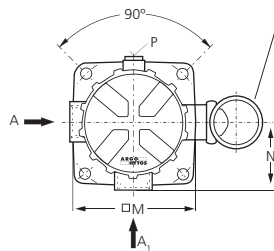
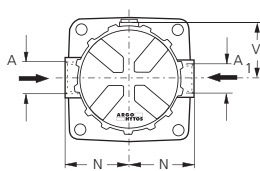

For dimension EV see selection chart

Measurements

Type	A	A1	B	C min/max	D	E	F	G	H	I	K	L	M	N	O	Q	R	S	U
E 212	G1¼	G1	126	118/121	95	110	11,5	32	105	325	213	165	141	76	11	35	23	113	28,5
E 222	G1¼	G1	126	118/121	95	110	11,5	32	105	455	347	165	141	76	11	35	23	113	28,5

Type	V	W	X	Z															
E 212	68	74	44	13															
E 222	67	74	44	13															

Symbols

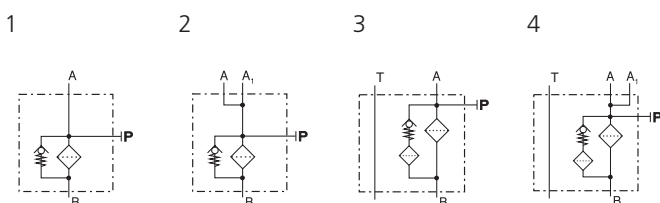

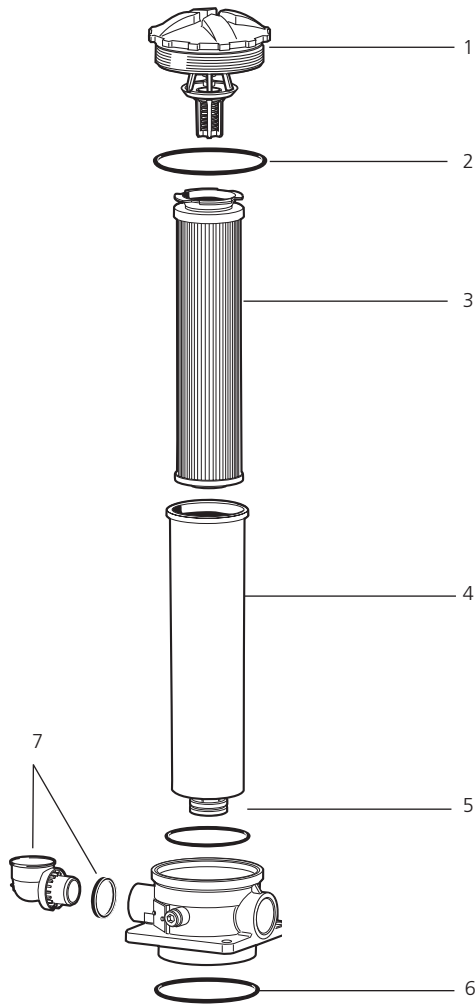

Pos.	Designation	Part No.
1	Screw-on cap with valve (2,5 bar) and Pos. 2	E 221.1200
1	Screw-on cap with valve (1,5 bar) and Pos. 2	E 221.1210
2	O-ring 100 x 4	N007.1004
3	Filter element	see Chart / col. 12
4	Filter bowl E 212*	E 212.0901
4	Filter bowl E 222*	E 222.0901
5	O-ring 90 x 4	N007.0904
6	O-ring 126 x 4	N007.1264
7	Connection for ventilating filter O-ring 31 x 4	E 222.1900

*Specify mounting depth (EV) in mm

The functions of the complete filters as well as the outstanding features of the filter elements assured by ARGO-HYTOS can only be guaranteed if original ARGO-HYTOS spare parts are used.

Quality Assurance

Quality management according to DIN EN ISO 9001

To ensure constant quality in production and operation, ARGO-HYTOS filter elements undergo strict controls and tests according to the following ISO standards:

- ISO 2941 Verification of collapse/burst pressure rating
- ISO 2942 Verification of fabrication integrity (Bubble Point Test)
- ISO 2943 Verification of material compatibility with fluids
- ISO 3968 Evaluation of pressure drop versus flow characteristics
- ISO 16889 Multi-Pass-Test (evaluation of filter fineness and dirt-holding capacity)
- ISO 23181 Determination of resistance to flow fatigue using high viscosity fluid

Various quality controls during the production process guarantee the leakfree function and solidity of our filters.

Illustrations may sometimes differ from the original. ARGO-HYTOS is not responsible for any unintentional mistake in this specification sheet.